

Inner Core (IC) Cables



Good flexibility and more cleaning power to the cable end.

	Catalog No.	Model No.	Description	Weight	
				lb.	kg
5/8" - 16mm	92460	C-25	25' IC Cable (7.6m)	24	10.9
	92465	C-26	50' IC Cable (15.2m)	43	19.5
	92470	C-27	75' IC Cable (22.9m)	63	28.6
	43647	C-24	100' IC Cable (30.5m)	84	38.1
3/4" - 20mm	92475	C-28	25' IC Cable (7.6m)	30	13.6
	92480	C-29	50' IC Cable (15.2m)	60	27.2
	41212	C-75	75' IC Cable (22.9m)	93	42.5
	41697	C-100	100' IC Cable (30.5m)	122	55.3









Hollow Core Cables

	Catalog No.	Model No.	Description	Weight	
				lb.	kg
5/8" - 16mm	32737	C-27HC	75' HC Cable (22.9m)	52¾	23.9
	58192	C-24HC	100' HC Cable (30.5m)	70½	32.1
3/4" - 20mm	47427	C-75HC	75' HC Cable (22.9m)	75	34.0
	47432	C-100HC	100' HC Cable (30.5m)	100	45.5

Leaders and Pig Tails







	Catalog No.	Model No.	Description	Weight	
				lb.	kg
	92555	T-458	5/8" x 2' Leader	2	0.85
	92560	T-468	3/4" x 2' Leader	2¾	1.25
	44122	—	5/8" Pigtail, 4½" Long	2½	1.13
	44117	—	¾" Pigtail, 6" Long	3½	1.59

Accessories

	Catalog No.	Model No.	Description	Weight	
				lb.	kg
	43637	A-7558	Drum Assembly w/5/8" Pigtail	33	15
	41982	A-7534	Drum Assembly w/¾" Pigtail	37½	17.0
	43642	A-75	AUTOFEED Assembly	8	3.5
	41992	—	C-100IC Kit w/Tools, ¾" x 100'	—	—
	49032	—	Front Guide Hose Assembly	3	1.3
	46015	E-453	Allen Wrench	—	—
	41937	—	RIDGID Leather Drain Cleaning Gloves	½	0.2
	70032	—	RIDGID PVC Drain Cleaning Gloves	½	0.2
	59360	A-3	Tool Box	5	2.3
	59987	—	Cable Rust Inhibitor 1 GAL.	8½	3.9
				oz.	g
	31487	A-7570	5/8" Repair Splicer	1½	43
	92805	A-6582	5/8" Male Coupling	1	28
	92810	A-6583	5/8" Female Coupling	2	57
	31492	A-7571	¾" Repair Splicer	2	57
	92880	B-6840	¾" Male Coupling	1	28
	92885	B-6841	¾" Female Coupling	2	57

Tools and Replacement Blades – Fit 5/8" and 3/4" Cables

C-24, C-25, C-26, C-27, C-28, C-29, C-75, C-100, C-27HC, C-24HC, C-75HC and C-100HC

	Catalog No.	Model No.	Description	Replacement	
				Blade(s)	Holder*
	92485	T-403	P-Trap Cutter, 3"	92835	92900
	92490	T-404	P-Trap Cutter, 3½"	92840	92900
	92495	T-406	Spear Blade, 1¾"	92850	92915
	92500	T-407	Retrieving Auger, 2¾/16"	—	—
	92505	T-408	Sawtooth Cutter, 3"	92890	92915
	51762	T-409	H-D Bulb Auger, 1¾"	—	—
	92510	T-411	Double Cutter, 2"	92815	92905
	92515	T-412	Double Cutter, 2½"	92820	92905
	92520	T-413	Double Cutter, 3"	92825	92910
	92525	T-414	Double Cutter, 4"	92830	92910
	92530	T-416	Double Cutter, 6"	92855	92910
		92535	T-432	3-Blade Cutter, 2"	92860
92540		T-433	3-Blade Cutter, 3"	92865	92895
92545		T-434	3-Blade Cutter, 4"	92870	92895
92550		T-436	3-Blade Cutter, 6"	92875	92895

QUICK-CONNECT CABLE & TOOLS

Rotate pin one-half turn in either direction to quickly add cable or tools:

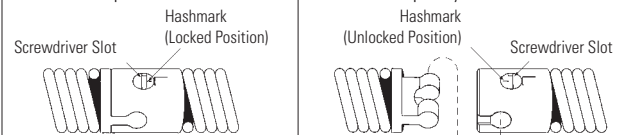

LOCKED

Hashmark "CLOSED" aligned with "L" stamped on coupling.

UNLOCKED

Hashmark "OPEN" aligned opposite "L" stamped on coupling.

Coupling features stainless steel pin and spring; eliminates need for punches, stands, or expansion pins.

For C-24, C-25, C-26, C-27, C-28, C-29, C-75, C-100, C-27HC, C-24HC, C-75HC, and C-100HC.

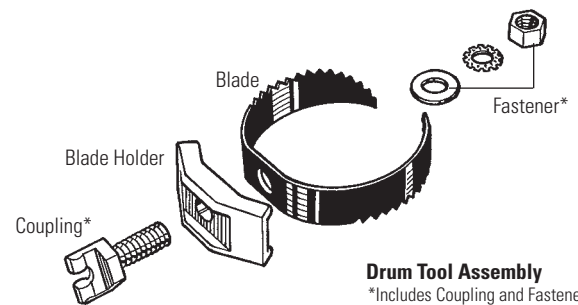

Drum Tool Assembly
*Includes Coupling and Fastener